



GUIL®

STANDS FOR SOUND & LIGHTING EQUIPMENT

2024



www.guil.es

GUIL,S.L.

P.I. la Creu C/ Ismael Tomás Alacreu, 28-30
46250 - L'Alcúdia, VALENCIA - SPAIN

Tel. + 34 962996500

Fax. + 34 962540833

E-mail: info@guil.es

Skype: [guil.export2](https://www.skype.com/people/guil.export2)



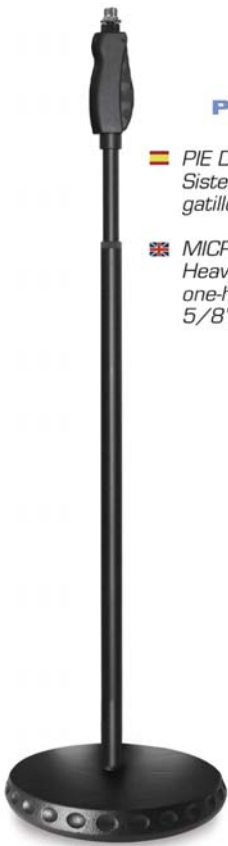

PM-40

PIE DE MICRO CON BASE REDONDA METÁLICA
Sistema de regulación de altura con bloqueo mediante gatillo. Doble rosca (3/8" - 5/8"). Incluye pasacables.

MICROPHONE STAND WITH ROUND BASE.
Heavy-duty microphone stand with round base and one-handed height adjustment. Double thread (3/8" - 5/8"). Clip-on cable holder included.

↕ + 150 - 96 cm
M Acero / Steel
C Negro / Black
⊘ 25 cm
⚖ 4,15 kg



PM-40/J

PIE DE MICRO CON JIRafa TELESCÓPICA
Pie de micro reforzado con jirafa telescópica y base redonda metálica, provisto de sistema de regulación de altura con bloqueo mediante gatillo. Doble rosca (3/8" - 5/8"). Incluye pasacables.

MICROPHONE STAND WITH TELESCOPIC BOOM ARM
Heavy-duty microphone stand with telescopic arm and round base. One-handed height adjustment. Double thread (3/8" - 5/8"). Clip-on cable holder included.

↕ + 85,5 - 48 cm
↕ + 161 - 106 cm
M Acero / Steel
C Negro / Black
⊘ 25 cm
⚖ 4,85 kg

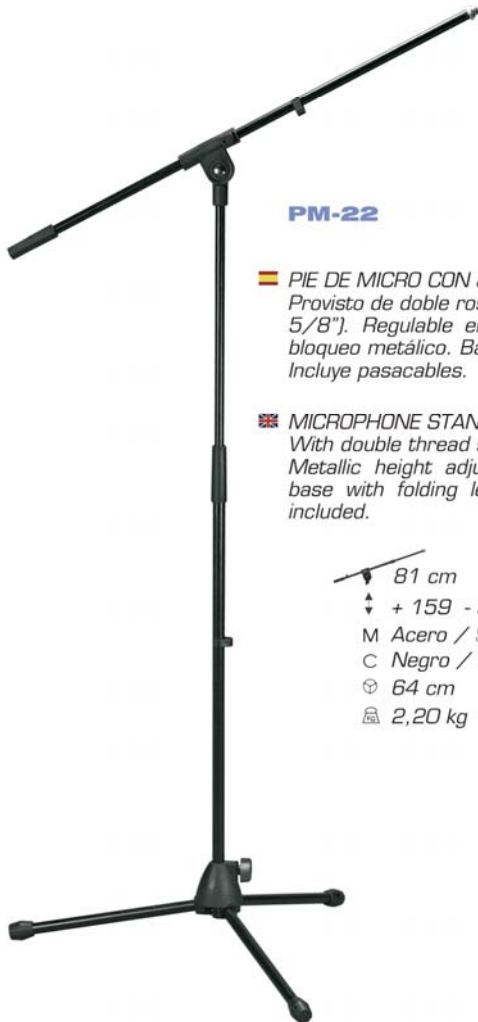

PM-22

PIE DE MICRO CON JIRafa
Provisto de doble rosca en el terminal (3/8" 5/8"). Regulable en altura con sistema de bloqueo metálico. Base plegable. Incluye pasacables.

MICROPHONE STAND WITH BOOM ARM
With double thread system (3/8" and 5/8"); Metallic height adjustment system. Metallic base with folding legs. Clip-on cable hold included.

↙ 81 cm
↕ + 159 - 97 cm
M Acero / Steel
C Negro / Black
⊘ 64 cm
⚖ 2,20 kg

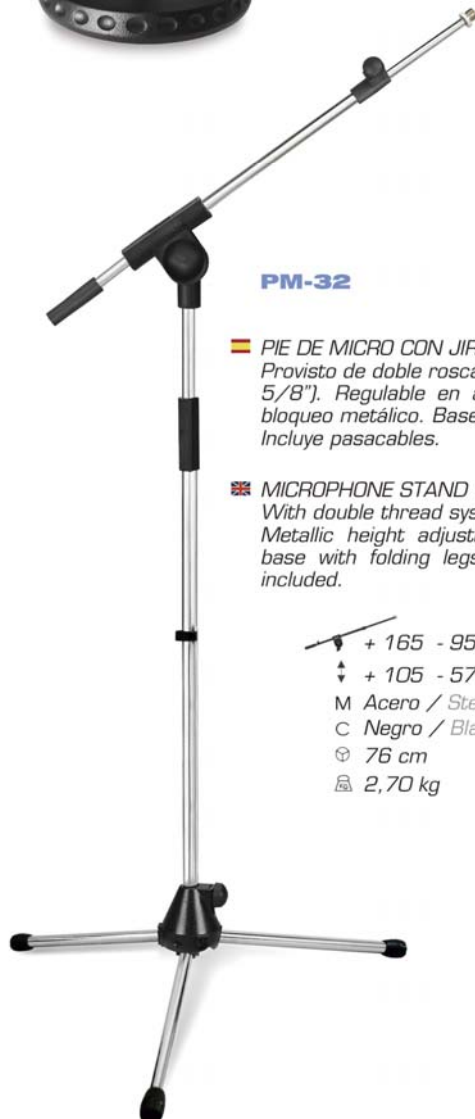

PM-32

PIE DE MICRO CON JIRafa
Provisto de doble rosca en el terminal (3/8" y 5/8"). Regulable en altura con sistema de bloqueo metálico. Base plegable. Incluye pasacables.

MICROPHONE STAND WITH BOOM ARM
With double thread system (3/8" and 5/8"). Metallic height adjustment system. Metallic base with folding legs. Clip-on cable holder included.

↙ + 165 - 95 cm
↕ + 105 - 57 cm
M Acero / Steel
C Negro / Black
⊘ 76 cm
⚖ 2,70 kg



PM-20

PIE DE MICRO CON JIRAFÁ TELESCÓPICA

De gran resistencia con doble rosca en el terminal (3/8" y 5/8"). Regulable en altura con sistema de bloqueo metálico. Base metálica plegable. Incluye pasacables.

MICROPHONE STAND WITH TELESCOPIC BOOM ARM

With double thread system, 3/8" and 5/8". Metallic base with folding legs. This heavy-duty mic stand comes complete with telescopic boom arm and clip-on cable holder.

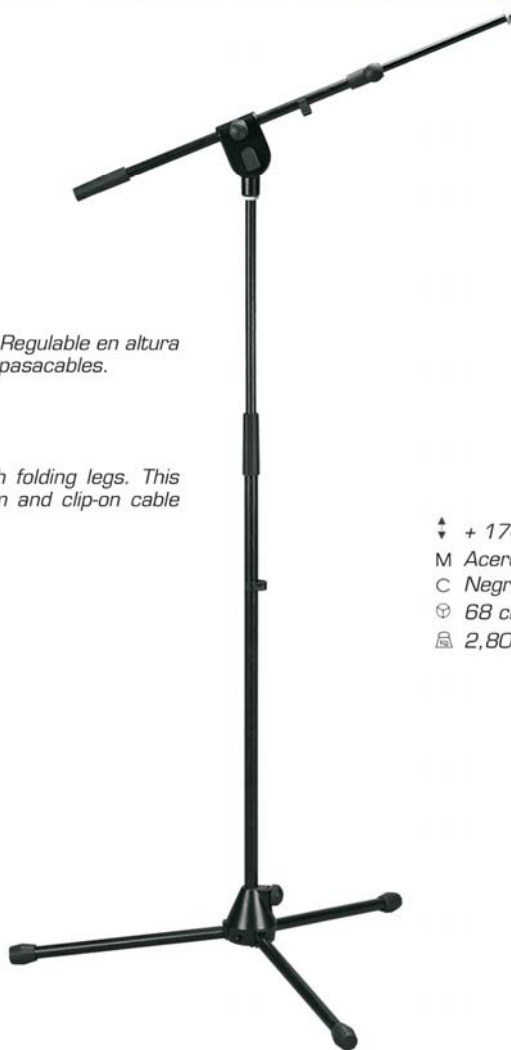

↑ + 174 - 102 cm
M Acero / Steel
C Negro / Black
⊘ 68 cm
⚖ 2,80 kg



PM-21

PIE DE MICRO MINI CON JIRAFÁ TELESCÓPICA

De gran resistencia con doble rosca en el terminal (3/8" y 5/8"). Regulable en altura con sistema de bloqueo metálico. Base metálica plegable. Incluye pasacables.

LOW-LEVEL MIC STAND WITH TELESCOPIC BOOM ARM

With double thread system (3/8" and 5/8"). Metallic base with folding legs. This heavy-duty mic stand comes complete with telescopic boom arm and clip-on cable holder.

↑ + 81 - 55 cm
M Acero / Steel
C Negro / Black
⊘ 56 cm
⚖ 2,10 kg

BL-04/2

BOLSA ACOLCHADA PARA 2 PIES DE MICRO

Compuesta por dos compartimentos independientes, cierre mediante velcro y dos asas para un cómodo manejo

PADDED BAG FOR 2 MICROPHONE STANDS. It has two padded sections and two comfortable handles

122 x 53 cm
M Nylon / Nylon
C Negro / Black
⚖ 0,50 kg





PM-46

PIE DE MICRO REFORZADO CON JIRAFAS TELESCÓPICA. SISTEMA REGULACIÓN DE ALTURA MEDIANTE GATILLO

- Incluye jirafa telescópica (Longitud: Min. 48 cm / Max. 85,5 cm).
- Doble Rosca 3/8" y 5/8".
- Incluye pasa-cables.
- Regulación de altura telescópica con sistema de bloqueo mediante gatillo.
- Base metálica muy resistente (plegable).
- Patas provistas de tacos antideslizantes para una mejor adherencia al suelo.
- Acabado en pintura negra texturada antirralladura.

HEAVY-DUTY MICROPHONE STAND WITH TELESCOPIC BOOM ARM. ONE-HANDED ADJUSTMENT.

- Its double brass thread system at the top makes it possible to attach any sort of clamp onto it without having to use any adaptors (3/8" and 5/8").
- It has a telescopic system to regulate the height, with special one-handed adjustment (min. length 48 cm, max. length 85 cm).
- Metallic base with folding legs.
- The legs have non-slip stoppers for a better grip to the floor.
- Includes clip-on cable holder.
- Has a textured, black, anti-scratch paint finish.

† + 163 - 110 cm
 M Acero / Steel
 C Negro / Black
 ∅ 70 cm
 ⚖ 2,64 kg



RC-06

ADAPTADOR DE ROSCA PARA MICRO
Aumenta la rosca del pie de micro de pequeña a grande (de 3/8" a 5/8").

THREAD ADAPTOR
Screws onto top of mic stand to change the thread size from 3/8" to 5/8".



RC-06/A

REDUCTOR DE ROSCA PARA MICRO
Reduce la rosca del pie de micro de grande a pequeña (de 5/8" a 3/8").

THREAD ADAPTOR
Screws onto top of mic stand to change the thread size from 5/8" to 3/8".



PM-28

PIE DE MICRO TELESCÓPICO DE SOBREMESA
Con base redonda metálica (∅ 16 mm).
Pinza de micro no incluida.

DESKTOP MICROPHONE STAND
Height adjustable with round metallic base (∅ 16 mm). Mic. clamp not included.

† + 33 - 20 cm
 M Acero / Steel
 C Negro / Black
 ∅ 16 cm
 ⚖ 1,26 kg



PM-19

ADAPTADOR TELESCÓPICO AÉREO PARA MICRO
Con doble rosca en el terminal (3/8" y 5/8"). Adaptable a soportes con tubos de hasta ∅ 25 mm.

TELESCOPIC BOOM ARM ADAPTOR
With double thread system (3/8" and 5/8"). This microphone arm attaches to stands with a tube diameter up to 25 mm. Non-marring knob with mounting plate prevents scratching of mic stand.

† - 48 cm + 85 cm
 M Acero / Steel
 C Negro / Black
 ⚖ 0,89 kg





PZ-01

PINZA INDEFORMABLE PARA MICRO
Provista de doble rosca (3/8" y 5/8"). Elástica y articulada. Máxima resistencia y durabilidad.

REINFORCED MICROPHONE CLAMP
With double brass thread system (3/8" and 5/8"). Made of special material which guarantees that clamp does not lose its shape, also guaranteeing a long lifespan and maximum durability.

↕ 7 cm
C Negro / Black
⚖ 0,04 kg



PZ-02

PINZA INDEFORMABLE PARA MICRO INALÁMBRICO
Provista de doble rosca (3/8" y 5/8"). Elástica y articulada. Máxima resistencia y durabilidad.

REINFORCED WIRELESS MICROPHONE CLAMP
With double thread system (3/8" and 5/8"). Made of special material which guarantees that clamp does not lose its shape, guaranteeing a long lifespan and maximum resistance.

↕ 8 cm
C Negro / Black
⚖ 0,045 kg



PZ-04

PINZA ARTICULADA PARA MICRO
Provista de rosca de 5/8"

ARTICULATED MICROPHONE CLAMP
With 5/8" thread.

↕ 7,5 cm
C Negro / Black
⚖ 0,04 kg



PZA-03

ADAPTADOR MÚLTIPLE PARA MICRÓFONOS
Dotado de rosca de 5/8". Permite colocar hasta 5 micrófonos.

MICROPHONE T-BAR
To be adapted to any standard mic stand for holding up to 5 microphones or boom arms. 5/8" Threads.

↔ 25 cm
M Acero / Steel
C Negro / Black
⚖ 0,50 kg



PM/TM-01

PIE DE MICRO CON JIRAFÁ PARA SU FIJACIÓN A TARIMAS GUIL
Este práctico pie de micro se fija al perfil multifuncional de la tarima, evitando tener que utilizar un pie de micro con una base convencional, dejando toda la superficie de la tarima disponible para el usuario.

MICROPHONE STAND WITH BOOM ARM TO FIT TO GUIL PLATFORMS
With this adaptor there is no need for the conventional base of the microphone stand which takes up space. This product leaves the whole platform free for the user

↕ + 87 - 49 cm
↕ + 140 - 75 cm
M Acero / Steel
C Negro / Black
⚖ 2,29 kg



PZ-05

ADAPTADOR DE MICRO A ARO DE BATERÍA
Adaptador para sujetar la pinza de micro a los aros de la batería (pinza no incluida), evitando soportes de micro adicionales en la sonorización.

MICROPHONE HOLDER FOR DRUMS OR MUSIC STANDS
Thanks to its rail design it is possible to place the microphone as near to the drum or music stand as needed. Provided with a 5/8" thread. Non-marring pressure knob prevents scratching of drum or music stand. Microphone clip not included.



↕ 10 cm ⚖ 0,10 kg

JR-05

JIRAFÁ TELESCÓPICA CON DOBLE ROSCA EN EL TERMINAL
Doble rosca en el terminal (3/8" y 5/8") y sistema de anclaje roscado. Adaptable a todos nuestros modelos.

TELESCOPIC BOOM ARM WITH
Double brass thread system (3/8" and 5/8") with a screwed anchorage system. Attaches to all Guil microphone stands.



↕ + 87 - 49 cm
M Acero / Steel
C Negro / Black
⚖ 0,66 kg



ALT-34

SOPORTE TELESCÓPICO PARA ALTAVOZ
Fabricado en acero con tramos telescópicos de Ø 40 y 35 mm (pared de 1 mm). El soporte, con terminal de Ø 35 mm, tiene doble sistema de bloqueo mediante pomo de presión y pasador de seguridad.

UK SPEAKER STAND

Made of steel with Ø 40 mm and Ø 35 mm telescopic sections (1mm metal thickness). Extension tube diameter 35 mm. Equipped with double safety locking system by means of "pressure knob" and "safety bolt".

± +207 cm - 127 cm

M Acero / Steel

C Negro / Black

⊕ 138 cm

⊖ 4,60 kg

⊖ 50 kg

⊖ 35 mm

2 Tramos / Sections

Ø 40; Ø 35 x 1 mm



ALT-12

SOPORTE DE ACERO PARA ALTAVOZ DE GRAN RESISTENCIA (100 kg)

Con dos tramos telescópicos de Ø 40 y 35 mm (pared de 1,5 mm). Diseñado con doble sistema de bloqueo mediante pomo de presión y pasador de seguridad. El soporte ALT-12, con terminal de Ø 35 mm, incluye anillo para evitar vibraciones. Está especialmente diseñado para grandes cargas (hasta 100 kg), siendo uno de los soportes más resistentes del mercado. Máxima seguridad y resistencia.

UK HEAVY-DUTY SPEAKER STAND (100 kg)

Made of steel with Ø 40 mm and Ø 35 mm telescopic sections (1.5 mm metal thickness). Extension tube diameter 35 mm. It is fitted with anti-vibration ring and equipped with double safety locking system by means of "pressure knob" and "safety bolt". It is specially designed to handle heavy loads (up to 100 kg), making it one of the strongest speaker stand in its class. It guarantees you maximum strength and durability.

± +215 cm - 130 cm

M Acero / Steel

C Negro / Black

⊕ 138 cm

⊖ 6,75 kg

⊖ 100 kg

⊖ 35 mm

2 Tramos / Sections

Ø 40; Ø 35 x 1,5 mm



ALT-36

SOPORTE DE ALTAVOZ CON SISTEMA DE ELEVACIÓN AUTOMÁTICO fabricado en aluminio con terminal de Ø 35 mm.

SPEAKER STAND WITH AUTOMATIC RAISING SYSTEM, manufactured in aluminium, with Ø 35 mm top tube.

± +200 cm - 132 cm

M Acero / Steel

C Negro / Black

⊕ 172 cm

⊖ 5,48 kg

⊖ 60 kg

⊖ 35 mm



ALT-37

SOPORTE DE ALTAVOZ CON SISTEMA DE ELEVACIÓN MEDIANTE CABRESTANTE, fabricado en aluminio con terminal de Ø 35 mm. Este trípode ligero y compacto, está diseñado para una carga máxima de 60 kg.

SPEAKER STAND WITH HAND WINCH LIFTING SYSTEM, manufactured in aluminium, with Ø 35 mm top tube. Lightweight with especially compact folded dimensions for easy transportation. Even the winch handle folds on itself.

± +225 cm - 140 cm

M Acero / Steel

C Negro / Black

⊕ 160cm

⊖ 6,00 kg

⊖ 50 kg

⊖ 35 mm





ALT-01



- **SOPORTE DE PARED ARTICULADO PARA ALTAVOZ**
Permite girar el soporte en cualquier ángulo (360°). Incluye cable de seguridad.

Distancia del altavoz a la pared: 13 cm.
Plancha para su fijación a la pared: 110 x 100 mm.
Plancha para sujeción del altavoz: 46 x 88 mm.
Peso: 0,45 kg Carga Máxima: 10 kg

- ✚ **SPEAKER WALL MOUNT**
Adjustable to any angle (360°). Mounts to wall or ceiling. It includes a safety sling.

Wall/ceiling clearance: 13 cm
Wall plate: 110 x 100 mm.
Adapter plate: 46 x 88 mm
Weight: 0.45 kg Maximum load: 10 kg

ALT-16



- **SOPORTE DE ALTAVOZ PARA INSTALACIÓN EN PARED**
Soporte reforzado de pared para altavoz, con terminal de inserción de Ø 35 mm.

- ✚ **SPEAKER WALL MOUNT**
Heavy-duty speaker wall mount with a 35 mm diameter mounting spigot.

↔ 22 cm - 35,2 cm
M Acero / Steel
C Negro / Black
Ø 35 mm
⚖ 1,9 kg
📦 50 kg

ALT-16/G



↔ 28,5 cm - 41,5 cm
M Acero / Steel
C Negro / Black
Ø 35 mm
⚖ 2,5 kg
📦 50 kg

- **SOPORTE PARA ALTAVOZ PARA SU FIJACIÓN A TRUSS**
Soporte reforzado para altavoz, con terminal de inserción de Ø 35 mm.

- ✚ **SPEAKER BRACKET TO ATTACH TO TRUSS**
Heavy-duty speaker wall mount with a 35 mm diameter mounting spigot.

LTA-07

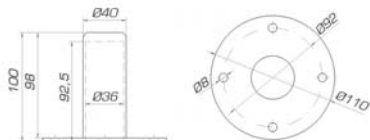

- **ADAPTADOR PARA ALTAVOZ, válido para soportes con terminal de Ø 35 mm.** El adaptador LTA-07 nos permite aumentar el diámetro del tubo del soporte de 35 a 40 mm.

- ✚ **STEEL SPEAKER FLANGE**
Steel flange for speakers with a 35 mm diameter ending. The LTA-07 adaptor allows the diameter of the support tube to be increased from 35 to 40 mm.

LTA-10



- **ADAPTADOR DE ALTAVOZ**
Para soportes con terminal de Ø 35 mm. Adaptable a cualquier altavoz gracias a sus seis puntos de anclaje, dos de ellos correderos.

- ✚ **MOUNTING ADAPTOR FOR SPEAKER STANDS**
It fits on top of 35 mm speaker stands. LTA-10 adaptor can be attached to many speakers thanks its six screw holes (two of them sliding).

ALT-14



- **SOPORTE TELESCÓPICO MINI PARA ALTAVOZ** Especialmente diseñado para espacios reducidos. Sistema de regulación gradual. Incluye adaptador de Ø 35 mm.

- ✚ **COMPACT SPEAKER STAND**
Specially designed for limited space and/or for low height applications. Gradual height adjustment. Fitted with Ø 35 mm adaptor.

↕ +150 cm - 110 cm
M Acero / Steel
C Negro / Black
Ø 74 cm
⚖ 2,45 kg
📦 20 kg
Ø 35 mm
2 Tramos / Sections
Ø 28; Ø 22 x 1,5 mm

BLC-03

- **BOLSA DE NYLON PARA 2 SOPORTES DE ALTAVOZ**
Con dos compartimentos. Cierres sin cremalleras.



- ✚ **NYLON BAG FOR TWO SPEAKER STANDS**
With two interior compartments.

121 x 51 cm
M Nylon / Nylon
C Negro / Black
⚖ 0,65 kg





ALT/TM-01

-  **SOPORTE TELESCÓPICO DE ALTAVOZ PARA SU FIJACIÓN A LAS TARIMAS GUIL.** Con este soporte se evita la base de un soporte convencional, dejando toda la superficie de la tarima disponible para el usuario.
-  **TELESCOPIC SPEAKER STAND WITH CONNECTOR TO FASTEN IT TO THE FRAME OF OUR PLATFORMS** With this adaptor there is no need for the conventional base of the music stand which takes up space.



M Acero / Steel
C Negro / Black
Ø 35 mm

MX-435

-  **SOPORTE DE GRAN RESISTENCIA PARA MIXER** Con base tipo doble "X". Regulable en seis alturas mediante pletina dentada. Diseño plegable. Máxima estabilidad.
-  **HEAVY-DUTY X-STYLE MIXER STAND** With double-braced design. Height and width can be adjusted to six different positions. Maximum stability. Folds flat for easy transport and storage.



↑ +106 cm - 66 cm
↔ +87 cm - 52 cm
M Acero / Steel
C Negro / Black
📦 9,70 kg
👤 80 kg

FCA-04

-  **ADAPTADOR PARA FOCO Y CAÑÓN DE SEGUIMIENTO,** marcador electrónico y todo aquel dispositivo con arco de montaje que queramos elevar por medio de un soporte o torre elevadora. Adaptable a soportes con tubo de Ø 35 mm.
-  **MOUNTING ADAPTOR FOR SPOTLIGHT & FOLLOWSPOTS** Practical adaptor to attach spotlights, followspots, electronic scoreboards or any type of device that has a yoke, which we want raise using a speaker stand or lifting tower. Fits on stands with a Ø 35 mm ending.

